

Solid Bronze Rustic

DOOR & CABINET HARDWARE

RDB1090 8" CABINET PULL RUSSELL DESIGN

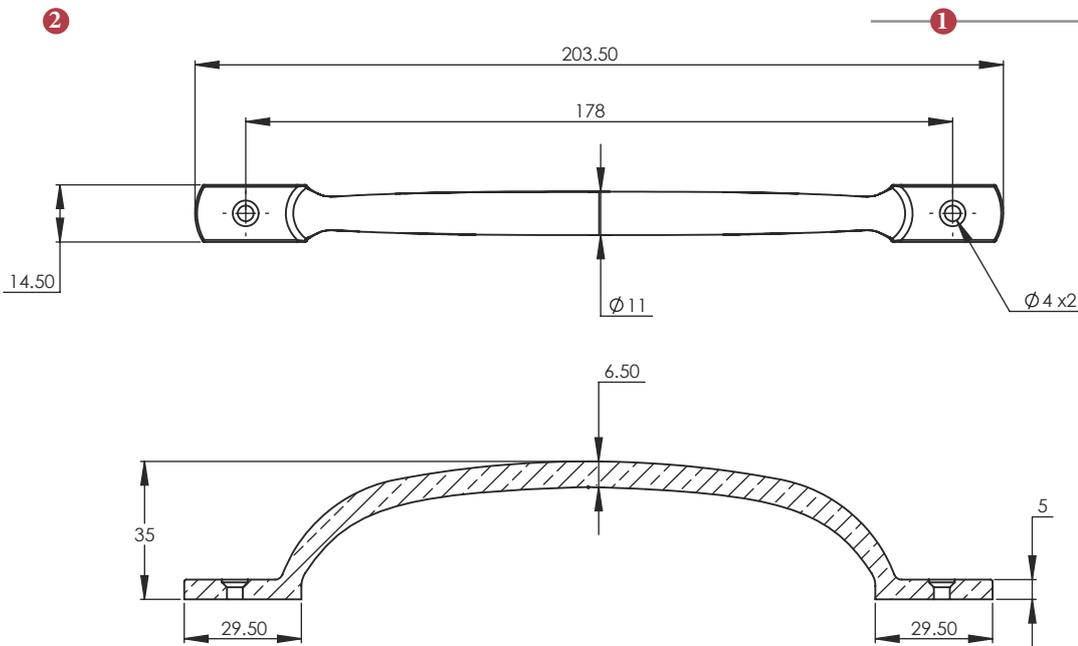

2 Dimensions:
see the outlines given above

3  Steel starter screw x 1pc
Drill pilot holes, use the starter screw to cut a thread

 Brass wood screws x 2pc
Fasten the wood screws into the pilot holes

Box Contains	1	2	3
	Sash Pull illustrated	General dimension of Sash Pull	Supplied with: 1x Steel starter screw 2x Brass wood screws

M Marcus Ltd., Dudley

Product Code	Material	Description	Sizes shown are in mm and approximate. We reserve the right to amend where necessary and without any prior notice.
RDB1090 203	Solid Bronze	Sash Pull in Rustic Dark Bronze finish	