

FLUSH RING CABINET PULL

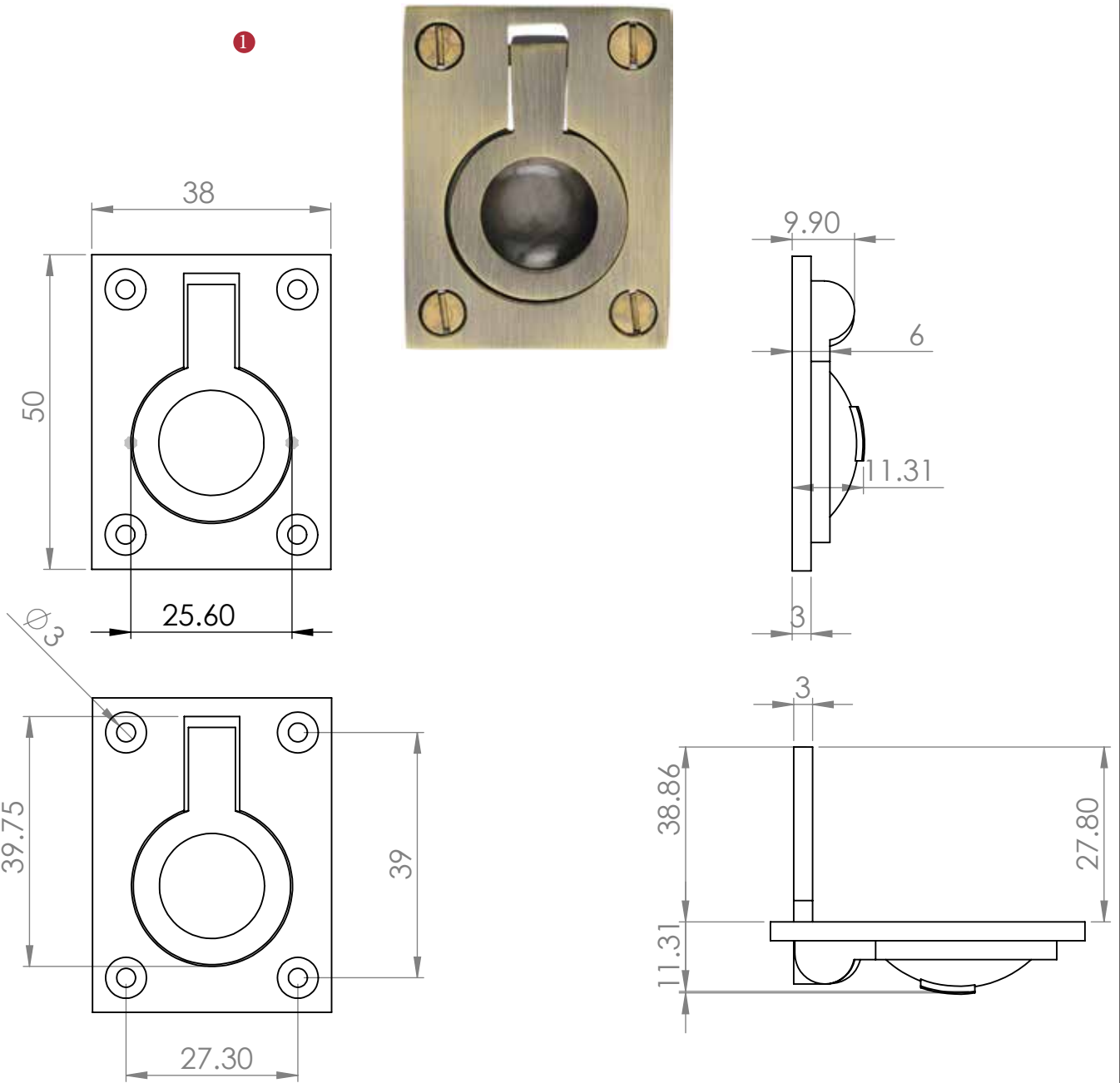

2



4 x No.4 x 3/4" CSK slotted woodscrews  
Fasten the Brass Screws into Pilot holes



Steel starter screw x 1pc.  
Drill pilot holes, use the starter screw to cut a thread

Box Contains

① Dimensions Flush Ring Cabinet Pull (as above)

② 4x Brass wood screws & 1x Iron screw

M Marcus Ltd., Dudley

Material	Product Code	Description	Sizes shown are in mm and approximate. We reserve the right to amend where necessary and without any prior notice.
Solid Forged Brass	C6337-38	Flush Ring Cabinet Pull	